

Orbitor Hi Cap

high capacity tank washing machine



Description

The Orbitor Hi Capacity tank cleaning machine is designed to deliver the most powerful cleaning of larger tank sizes. With jet lengths spanning a radius of 13m to 21m (depending on nozzle size & operating pressure – see overleaf) the machine can readily tackle 26m to 42m tank diameters. For larger or more complex structures, shadow studies can be commissioned to ensure optimum placement of multiple machines for 100% cleaning.

With quality components, materials & finishing the machine is highly suited to a wide variety of industrial and hygienic applications. The Orbitor Hi Cap makes light work of cleaning the toughest residues including highly viscous materials. It can be readily combined with hot water cleaning to shift even the most resistant / hardened substances making it ideal for many process applications. ATEX certification available on request.

Each unit is fully self lubricating & self cleaning to prevent contamination & can be safety certified for use in ATEX regulated applications. The Orbitor Hi Cap can be supplied as a fixed or portable machine in 2 finishes: standard or hygienic.

Range	Orbitor 100	Orbitor 4 Nozzle	Orbitor Double Nozzle	Orbitor Dual Head	Orbitor Hi Cap	Orbitor DT
Tank Ø	< 5m - 12m	< 10m - 26m	< 12m - 29m	< 30m *down wash	< 26m - 42m	Bespoke

Machine Features

- Powerful cleaning; ideal for larger tank to Ø 42m
- Safety & quality certified to ATEX /BV standard for use in hazardous environments
- Configured to order, reducing water consumption
- Designed with minimum moving parts to ensure extended operating life, reduced down time & ease of maintenance
- Self-cleaning & lubricating to avoid contamination
- Available in 2 surface finishes: standard & hygienic
Materials of manufacture:-
Body 316L Stainless Steel
Gears PEEK
Bushes Carbon PTFE

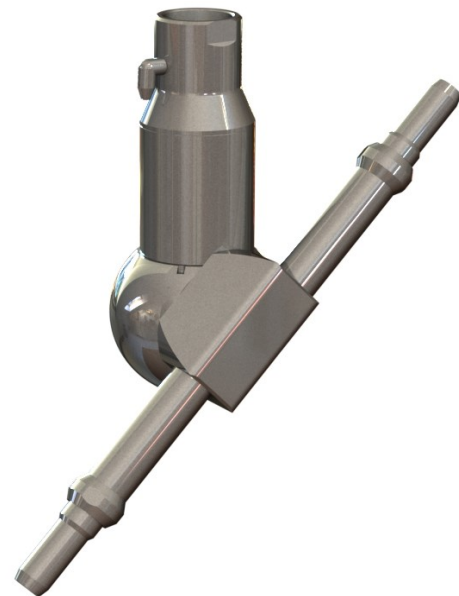

Technical Information

Nozzle sizes	10mm or 12.5mm
Min tank opening	Ø 140mm
Weight	12.5kg
Inlet connection	1.5" BSP/NPT
Operating temperature	up to 95°C (to 60°C/ATEX)
Cycle/Wash times	dependant on specification range approx 9-16 min

Typical Scope of Supply

Fixed machine

- 1x Orbitor Hi Cap machine
- 1x Down pipe with mounting flange & valve
- 1x User operation & maintenance manual

Portable machine

- 1x Orbitor Hi Cap machine
- 1x Layflat hose
- 1x Hose saddle
- 1x User operation & maintenance manual



**Innovation
that delivers**

Orbitor Hi Cap

high capacity tank washing machine



Machine Data

Supply Pressure Kg/cm ²	Jet Length (m) at Nozzle Size (mm)	
	10 mm	12.5 mm
5	13.0	13.0
6	14.5	15.0
7	16.0	17.0
8	17.5	18.5
9	19.0	20.0
10	20.0	21.0

Typical applications

- Food
- Beverage
- Chemical
- Pharmaceutical
- Petrochemical
- Utilities
- Marine
- General large tank cleaning

Supply Pressure Kg/cm ²	Flow (m ³ /h) at Nozzle Size (mm)	
	10 mm	12.5 mm
5	17.4	26.4
6	19.2	28.8
7	21.0	31.2
8	22.2	33
9	23.4	34.8
10	24.2	35.5

2 Nozzle Spray Pattern

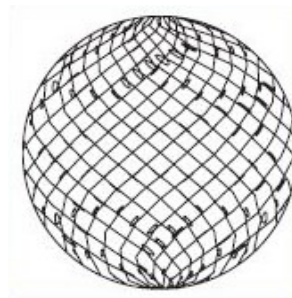

Machine Dimensions

Portable machine

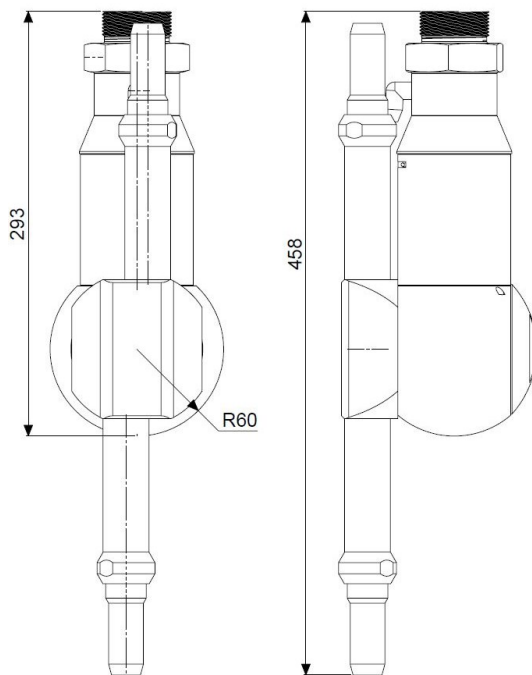

Fixed machine

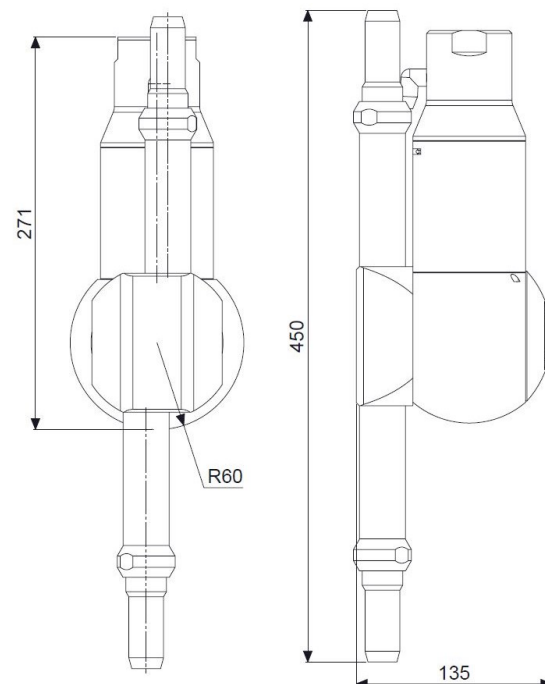

Dasic Tankclean Ltd, Eagle Close, Eastleigh, Hampshire, S053 4NF, United Kingdom.

Tel: +44 (0) 23 80252264 Fax: +44 (0) 23 80266233

Email: enquiries@dasic-tankclean.co.uk Web: www.dasic-tankclean.co.uk

Document No: SB010 Iss 01 19/02/16